



5592

5592

# POWER TRIODE

FORCED-AIR-COOLED, GROUNDED-GRID TYPE

## GENERAL DATA

### Electrical:

Filament, Multistrand Tungsten:

Excitation . . . Single-Phase AC or DC

Voltage . . . . . 11 . . . . . ac or dc volts

Current . . . . . 412 . . . . . amp

Starting Current: The filament current must never exceed 750 amperes, even momentarily.

Cold Resistance . . . . 0.0026 . . . . . ohm

Amplification Factor . . . . . 32

Direct Interelectrode Capacitances (Approx.):

Grid to Plate . . . . . 35 . . . . .  $\mu\text{f}$

Grid to Filament . . . . 76 . . . . .  $\mu\text{f}$

Plate to Filament . . . . 1.2 . . . . .  $\mu\text{f}$

### Mechanical:

Terminal Connections:

F - Filament Posts

G - Grid-Flange

Terminal

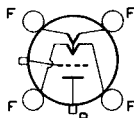

P - Radiator-Cooled Plate Terminal

DIAMETRICALLY OPPOSITE TERMINALS MUST BE CONNECTED TOGETHER

Mounting Position . . . . . Vertical, Filament end up

Maximum Overall Length . . . . . 17-3/8"

Maximum Diameter . . . . . 14-1/4"

Radiator . . . . . Integral part of tube

Mounting . . . . . Special

### Air Flow:

Through Radiator (for max. ratings) . . . . 1100 min. cfm

The specified air flow at a pressure of 2.4 inches of water should be delivered by a blower vertically upward through the radiator. Air flow should be started before the application of any voltages.

To Filament Seals . . . . . 200 min. cfm

The specified air flow from a duct 8 square inches in area directed into the filament header before and during the application of any voltages, is required to limit the temperature of the header and filament seals to the maximum value.

Input-Air Temperature (to radiator) . . . . 45 max. °C

Radiator Temperature (measured in thermometer well) . . . . 180 max. °C

Bulb Temperature . . . . . 180 max. °C

Seal Temperature (filament, grid, plate) . . . . 165 max. °C

### RF POWER AMPLIFIER & OSCILLATOR - Class C Telegraphy

Key-down conditions per tube without amplitude modulation<sup>□</sup>

### Maximum CCS<sup>•</sup> Ratings, Absolute Values:

DC PLATE VOLTAGE . . . . . 11500 max. volts

DC GRID VOLTAGE . . . . . -2000 max. volts

DC PLATE CURRENT . . . . . 4.5 max. amp

DC GRID CURRENT . . . . . 0.8 max. amp

□, •: See next page.

5592



# 5592 POWER TRIODE

PLATE INPUT . . . . .	50 max. . . . .	kw
PLATE DISSIPATION . . . . .	17.5 max. . . . .	kw

### Typical Operation in Grounded-Filament Circuit:

DC Plate Voltage . . . . .	7500	11000	..	volts
DC Grid Voltage <sup>■</sup> . . . . .	$\left\{ \begin{array}{l} -360 \\ 600 \\ 75 \end{array} \right.$	-820	..	volts
		1000	..	ohms
		200	..	ohms
Peak RF Grid Voltage . . . . .	900	1450	..	volts
DC Plate Current . . . . .	4.4	3.6	..	amp
DC Grid Current (Approx.) <sup>*</sup> . . . . .	0.6	0.8	..	amp
Driving Power (Approx.) <sup>*</sup> . . . . .	450	1000	..	watts
Power Output (Approx.) . . . . .	20	30	..	kw

### Typical Operation as Amplifier in Grounded-Grid Circuit at 108 Mc:<sup>▲</sup>

DC Plate Voltage . . . . .	7500	..	volts
DC Grid Voltage <sup>■</sup> . . . . .	$\left\{ \begin{array}{l} -1000 \\ 1650 \\ 200 \end{array} \right.$	..	volts
		..	ohms
		..	ohms
Peak RF Grid Voltage . . . . .	1550	..	volts
DC Plate Current . . . . .	4.4	..	amp
DC Grid Current (Approx.) <sup>*</sup> . . . . .	0.6	..	amp
Driving Power (Approx.) . . . . .	9000	..	watts
Power Output (Approx.) . . . . .	27	..	kw

□ Modulation essentially negative may be used if positive peak of the audio-frequency envelope does not exceed 115% of the carrier conditions.

● Continuous Commercial Service.

■ obtained by grid-resistor (600,1000), cathode-resistor (75,200) or by partial self-bias methods.

\* Subject to wide variations as explained on sheet TUBE RATINGS in General Section.

▲ For Class C Telephony or Class C FM Telephony.

Data on operating frequencies for the 5592 are given on the sheet TRANS. TUBE RATINGS vs FREQUENCY.

### FILAMENT CONNECTIONS

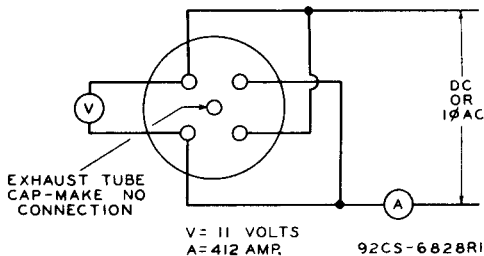

APRIL 15, 1947

TUBE DEPARTMENT

TENTATIVE DATA

RADIO CORPORATION OF AMERICA, HARRISON, NEW JERSEY



5592

# POWER TRIODE

5592

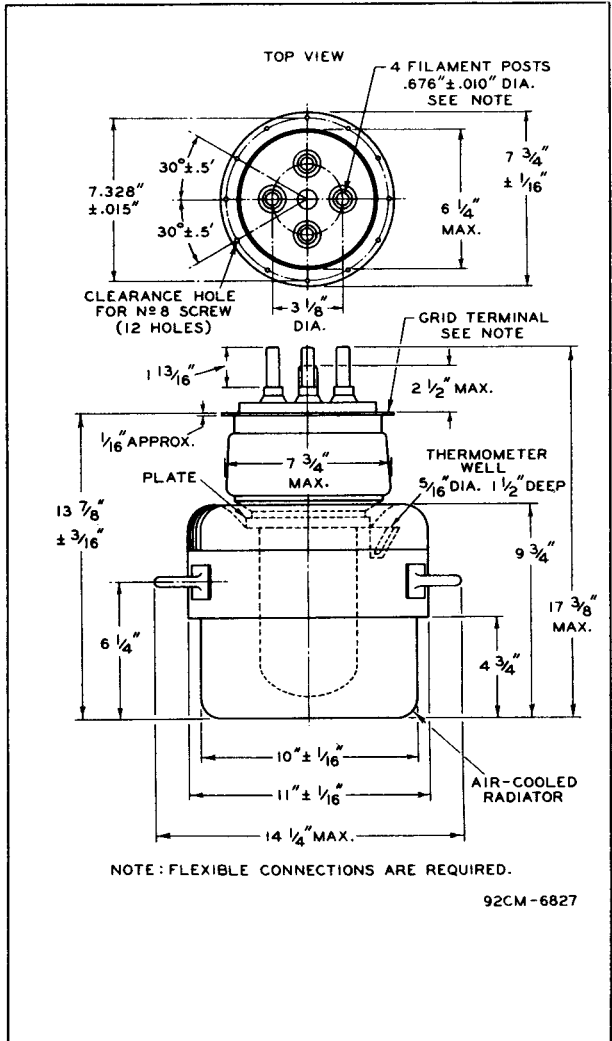

5592



5592

## AVERAGE FILAMENT CHARACTERISTIC

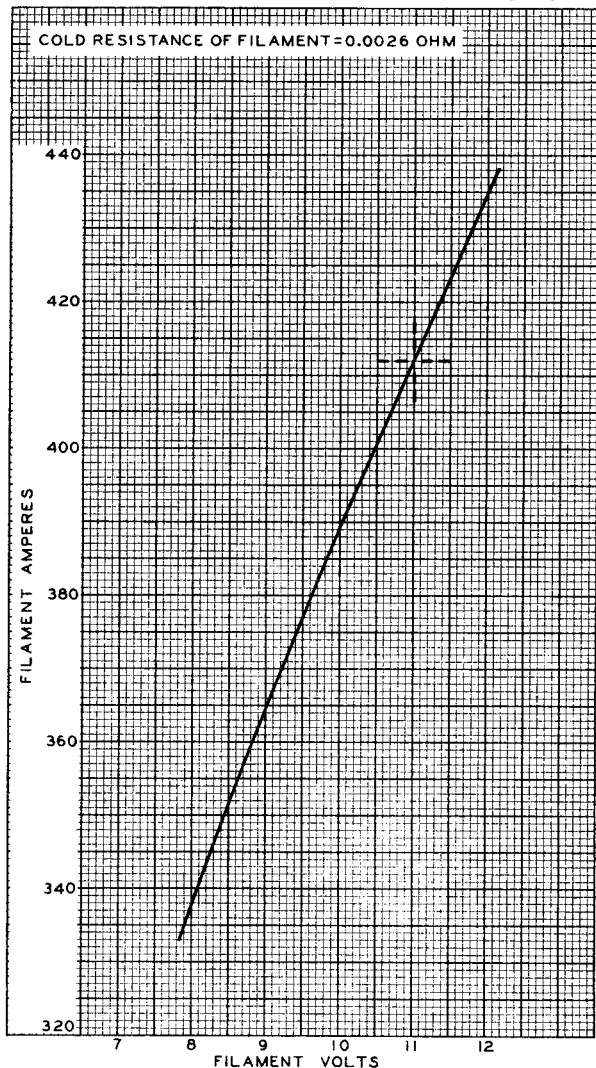

FEB. 7, 1947

TUBE DEPARTMENT  
RADIO CORPORATION OF AMERICA, HARRISON, NEW JERSEY

92CM-6839



5592

5592

### AVERAGE FILAMENT-EMISSION CHARACTERISTIC

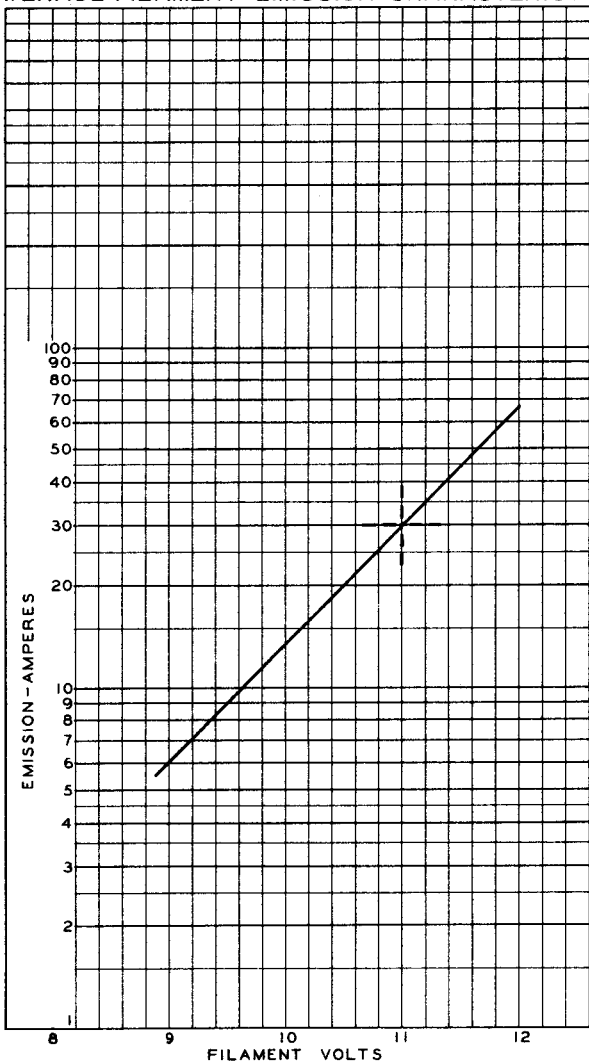



## COOLING REQUIREMENTS

E<sub>f</sub> = 11 VOLTS AC

MAXIMUM RADIATOR TEMPERATURE = 180°C

CURVE	PRESSURE DROP INCHES OF WATER
A	1.3
B	2.0
C	2.9

CURVES TAKEN ACCORDING TO  
NAFM\* STANDARDS—  
BULLETIN №103

\* NATIONAL ASSOCIATION OF FAN MFRS.,  
GENERAL MOTORS BLDG., DETROIT, MICH.

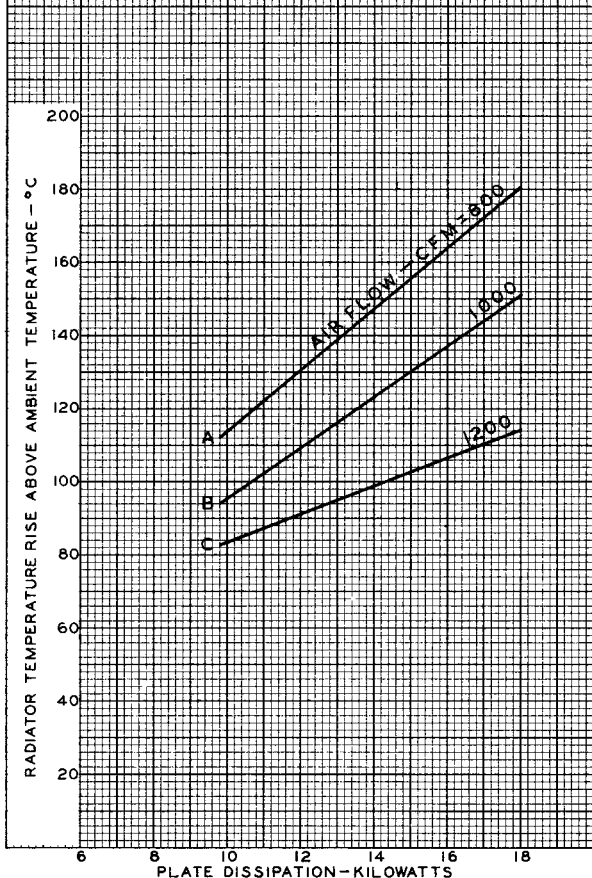



5592

5592

# AVERAGE PLATE CHARACTERISTICS

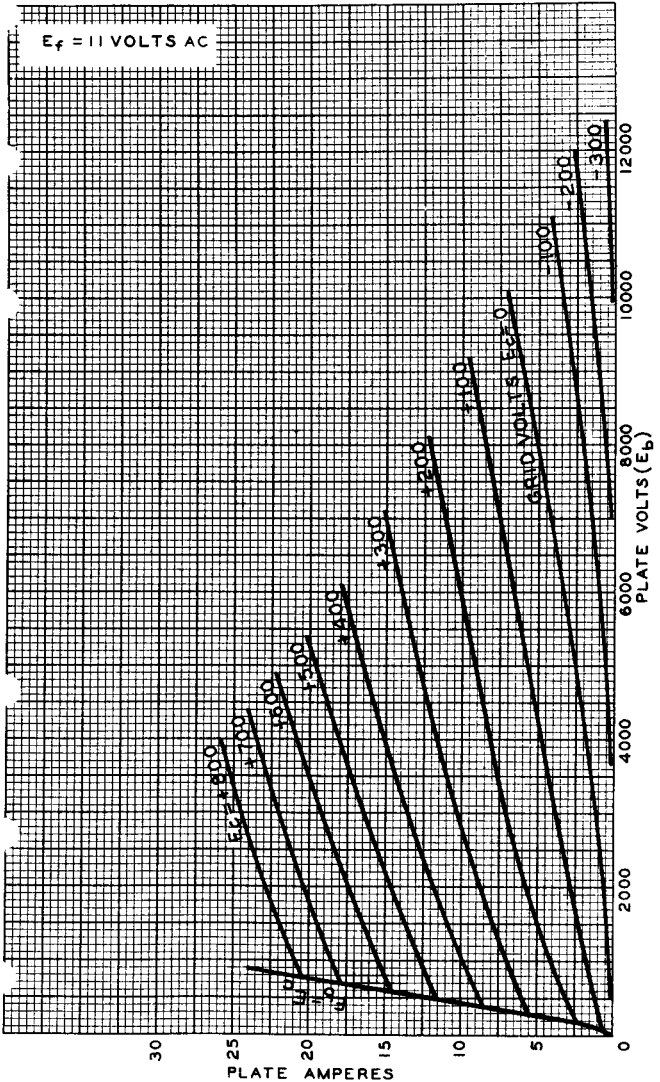

MAR. 3, 1947

TUBE DEPARTMENT

92CM-6843

RADIO CORPORATION OF AMERICA, HARRISON, NEW JERSEY

5592



5592

### TYPICAL GRID CHARACTERISTICS

$E_f = 11$  VOLTS AC

